

ALKON MODULAR SYSTEMS - BEIGE / GREY / BLUE

Modular System - Beige / Grey / Blue

is an ideal plastic filing system based on standard modules which can be interlocked and stacked on top of each other.

The basic system is around four drawer sizes which can be interchanged in the ratio of 1 : 2 : 3 : 4. all cabinets can be supplied with / without central locking system.

Applications

Due to the system being modular in nature, these systems are used in a large variety of applications like Offices, Hospitals, Homes, Electronics, Engineering and Textile Industries.

MODULAR SYSTEMS -BEIGE

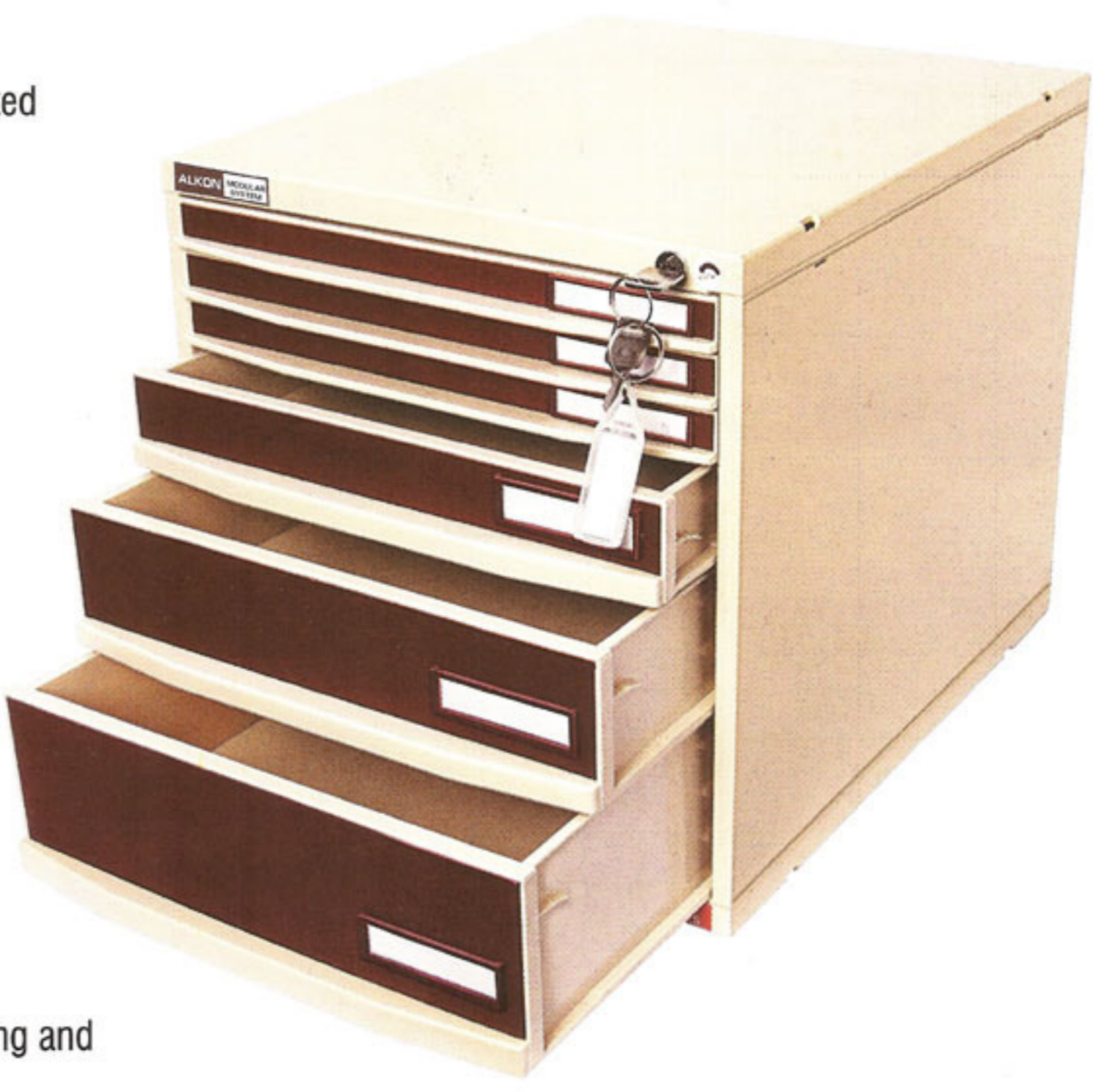

CABINET & DRAWERS DRAWER FRONT
COLOUR [Beige] [Dark Brown]

MODULAR SYSTEMS- GREY

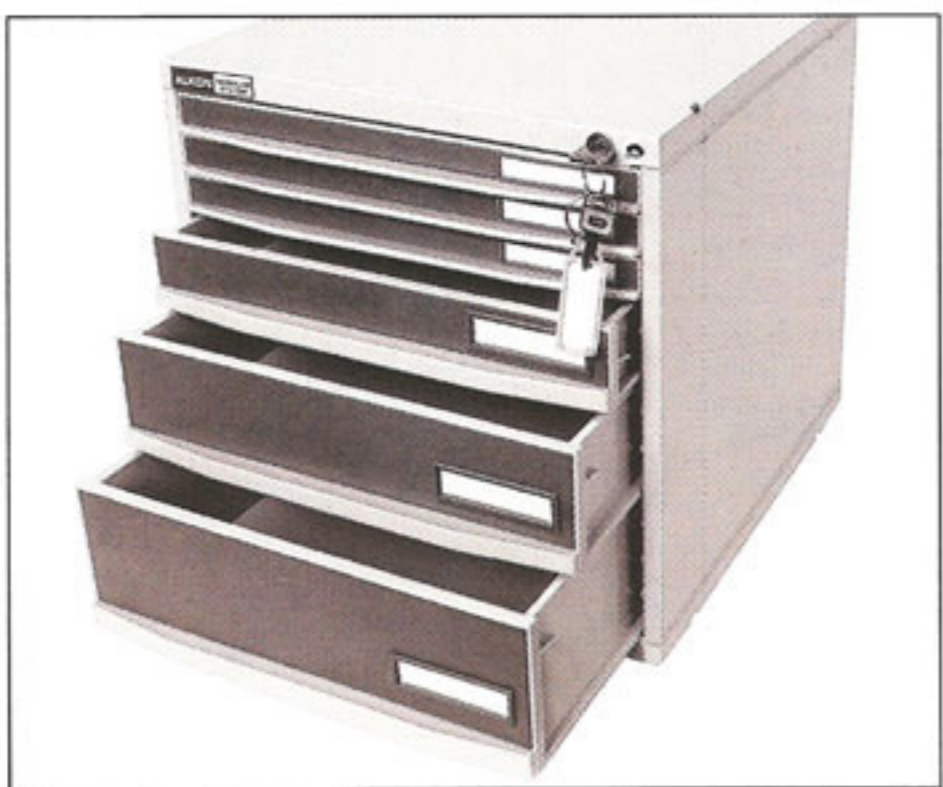

CABINET & DRAWERS DRAWER FRONT
COLOUR [Grey] [Dark Brown]

MODULAR SYSTEMS-BLUE



CABINET & DRAWERS DRAWER FRONT
COLOUR [Grey] [Dark Blue]

Bombay Stationers
Pvt. Ltd.

BOMBAY STATIONERS PVT LTD

1st FLOOR, X-21, COMMERCIAL COMPLEX, BESIDE HOTEL OISES, M.I.D.C. AREA, WALUJ, AURANGABAD (MS)
Phone: +91-240-2654153 / 54
E-mail: info@bombaystationers.com

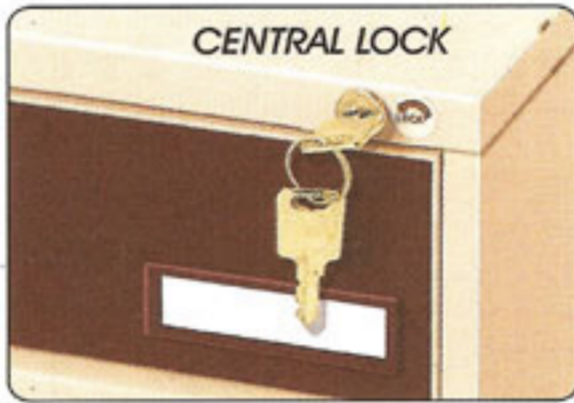
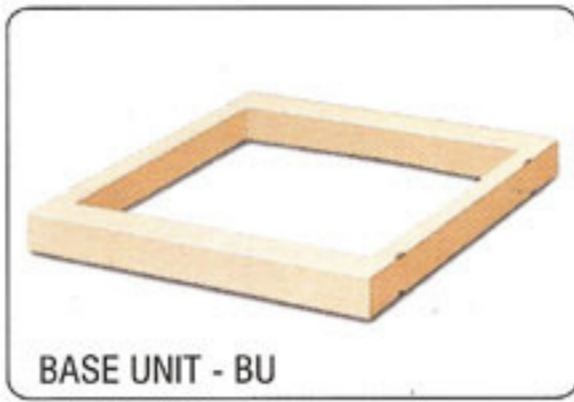
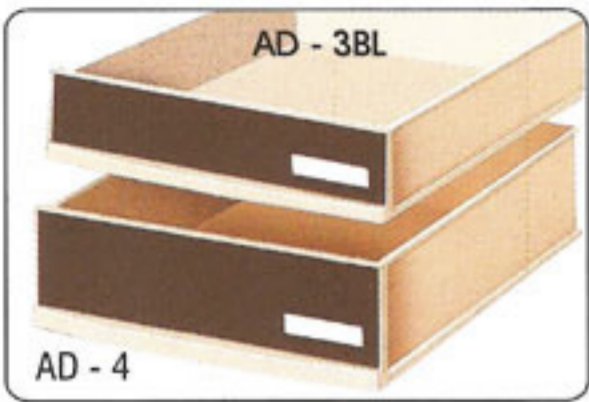
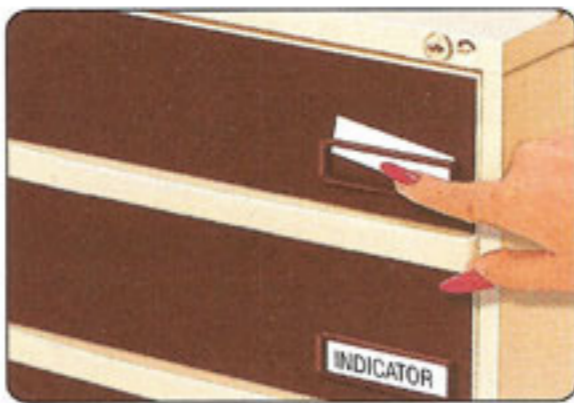
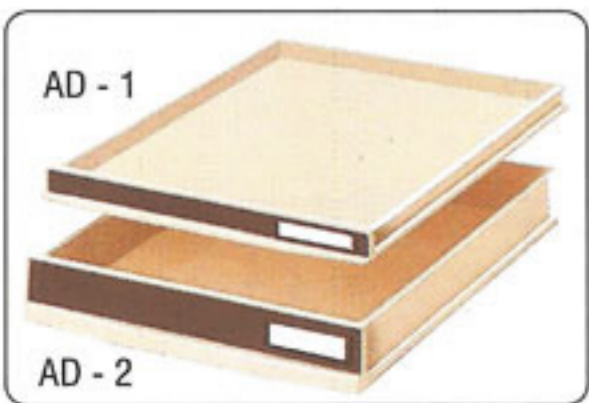

SPECIAL STOPPERS
Special stopper is provided to stop the drawers when opened fully. To remove drawer from the cabinet lift the drawer up & remove from cabinet.

INTERNAL SIZE OF DRAWERS
AD 1 360 mm x 265 mm x 16 mm
AD 2 360 mm x 265 mm x 39 mm
AD 3 360 mm x 265 mm x 62 mm
AD 4 360 mm x 265 mm x 87 mm
AMS 12-Modular system with 12 AD 1 Drawers
AMS 6 - Modular system with 6 AD 2 Drawers
AMS 4 - Modular System with 4 AD 3 Drawers
AMS 3 - Modular System with 3 AD 4 Drawers

MIXED DRAWER SYSTEM
Modular System can be fitted with different size of drawers in the same cabinet. For example, One AD-4 cabinet, can be replaced by two AD -2 drawers, or one AD -3 drawer and one AD-1 drawer.

INDICATOR
Name plate can be changed by pushing out the paper from the indicator as shown.

BASE UNIT
Base unit can be used with castors to make a mobile unit. One or more base units can be used (Joined by set of four dowels provided) under the Modular system to raise the cabinet from the floor. Height of base unit is 35mm.

CENTRAL LOCKING SYSTEM
Is provided OPTIONALLY. Product numbers for cabinet with locks will be AMS 12L, AMS 6L, AMS 4L ect.

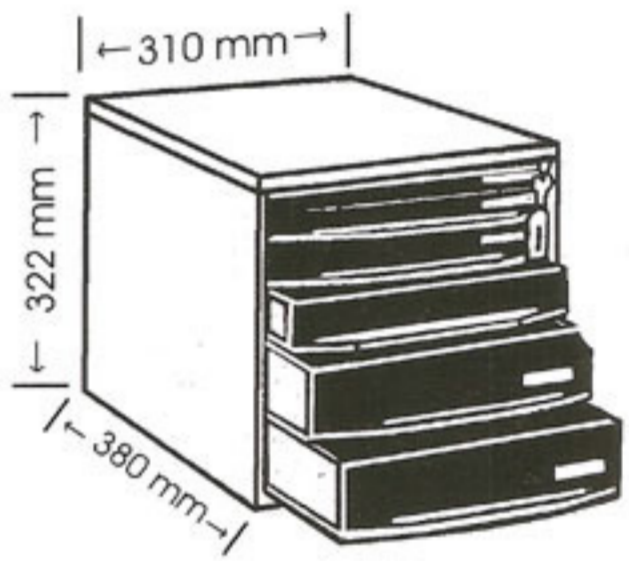

UTILITY CONTAINERS
For storing of small parts, Three sizes of containers are available to fit in AD3 drawers.

Utility Containers available in 3 Sizes (in Beige & Grey Colours)
UC 1 size 82 x 82 x 55
UC 2 size 170 x 82 x 55
UC 3 size 255 x 82 x 55

